

C BDC 3.40-4.80 GHz 1 Band

Key features

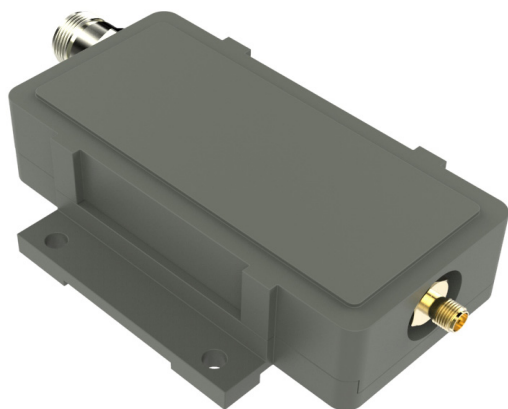

- Internal Interference mitigating filters
- Low phase noise to meet DVB-S2X VSAT profile
- High P1dB and IP 3
- Choose between Internal Reference or External 10 MHz reference models
- Wide operating temperature range
- For outdoor use, IP 67 classed
- Low profile to fit 1U (optional)

Description

The C-Band PLL block down converter is intended for receiving C-Band transmissions within the frequency range 3.40 to 4.80 GHz. Fixed gain configurable between 0 dB and 50 dB (factory set). It's normally used together with an external C-band low noise amplifier (LNA).

RF input is SMA female. IF output is standard L-Band inverted spectrum via N-, F- or SMA- connector. Options include customized LO, customized gain, separate DC power input or separate input for the external 10 MHz reference.

BDC connector standard

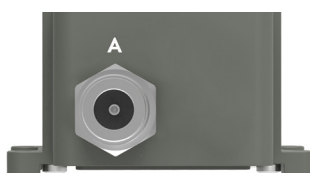

Connector A (standard)

Type: N-female, (option F-female or SMA-female)
Functions: L-Band out, DC in, External 10 MHz in

BDC connector optional

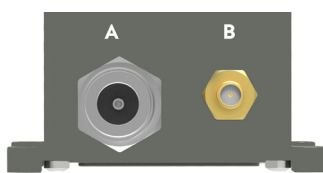

Connector B (optional)

Type: SMA-female
Functions: External DC or Ext. 10 MHz ref. input.



Explore our full product range in this category



C BDC 3.40-4.80 GHz 1 Band

Technical specifications

	Name	Input Frequency	LO Frequency	Output Frequency
MODEL	5.15 S	3.625–4.200 GHz	5.15 GHz	1525 - 950 MHz
	5.15 E	3.400–4.200 GHz	5.15 GHz	1750 - 950 MHz
	5.15 B	3.700–4.200 GHz	5.15 GHz	1450 - 950 MHz
	5.30 C	3.800–4.200 GHz	5.30 GHz	1500 - 1100 MHz
	5.75 W	3.600–4.800 GHz	5.75 GHz	2150 - 950 MHz
	5.75 U	4.500–4.800 GHz	5.75 GHz	1250 - 950 MHz
	5.95 U	4.500–4.800 GHz	5.95 GHz	1450 - 1150 MHz
INPUT	Input	SMA female 50 Ω		
	Input VSWR	2.3:1 max.		
	DC Input	+12 to +18 V, 430 mA typ. Supplied through output connector.		
INTERNAL	Gain	By request, 0 dB to 50 dB in 5 dB steps (Factory programmable)		
	Flatness	± 0.4 dB max. within 30 MHz, full band ± 2 dB except model 5.75 W (± 3 dB)		
	Noise figure	3.0 dB / 289 K typ. @ 50 dB gain, increasing to 20 dB / 28710 K @ 0 dB gain		
	MODELS with Internal reference	± 1 ppm -40 to +60°C (± 1.5 ppm -40 to +80°C)		
	MODELS with External reference	Sine Wave, Level: -15 to +5 dBm. Supplied through output connector. With no ext. 10 MHz ref. present LO shifts -20 ppm.		
	Phase Noise	-40dBc/Hz • 10 Hz -62dBc/Hz • 100 Hz -80dBc/Hz • 1 kHz -88dBc/Hz • 10 kHz -95dBc/Hz • 100kHz -112Bc/Hz • ≥ 1 MHz (typ.)		
	Phase Noise 5.75 W	-62dBc/Hz • 100 Hz -80dBc/Hz • 1 kHz -83dBc/Hz • 10 kHz -95dBc/Hz • 100kHz -112Bc/Hz • ≥ 1 MHz (typ.)		
	Group delay	± 1 ns max.		
	LO Leakage	-60 dBm max. @ RF input		
	Image Rejection	40 dB min.		
OUTPUT	Output P1dB	+15 dBm typ., +5 dBm @ gain 10 dB and below gain configuration typ.		
	Output IP3	+25 dBm typ., +15 dBm @ 10 dB and below gain configuration typ.		
	Output VSWR	2.1:1 max.		
	Output Connector	F-type 75 Ω , N-type 50 Ω or SMA-type 50 Ω		
GENERAL	Temperature range	Storage and operating: -40 to +80°C, -40 to +176°F		
	Dimensions	127 x 80 x 30 mm (F- & SMA-connector), 133 x 80 x 30 mm (N-connector), for drawing, see www.smw.se		
	Weight	330 g (F- & SMA-connector) 344 g (N-connector)		
	MTBF	MTBF as per MIL-HDBK-217F Notice 2: Environmental Condition GF (Ground Fixed): >489000 hours, Environmental Condition AIC (Airborne, Inhabited, Cargo): >245000 hours, Quality level: Commercial, Temp used for MTBF calculation: +35 C Ambient		
OPTIONS	Separate SMA connector for DC input or Ext. 10 MHz ref. Custom LOs, Custom input frequencies, Custom gain and variation Low profile to fit 1U			

C BDC 3.40-4.80 GHz 1 Band

Technical Drawing

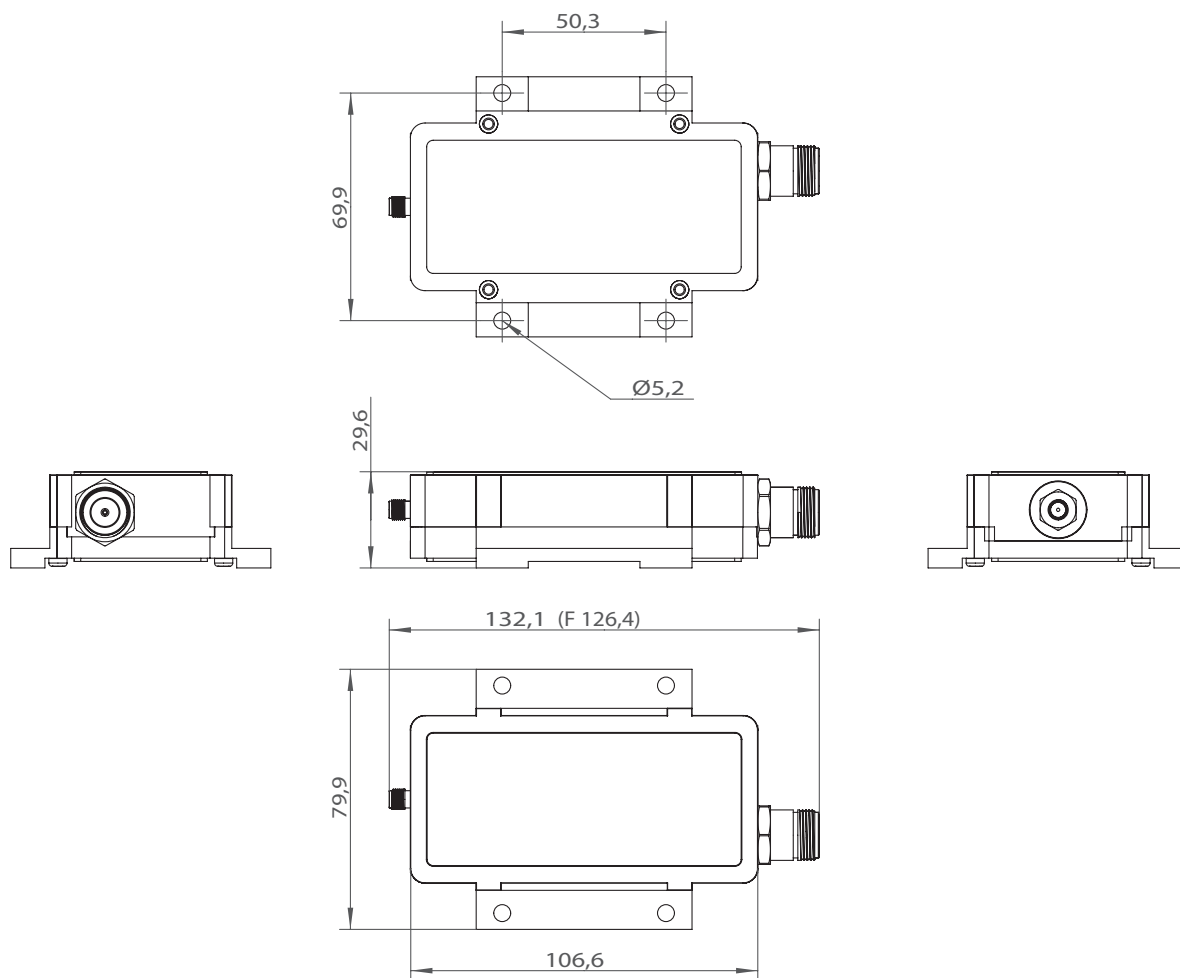

C BDC 3.40-4.80 GHz 1 Band

Internal RF filters

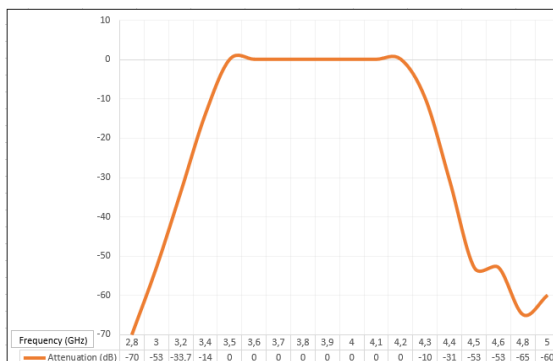

Filter characteristics for
model 5.15 S
3.625 - 4.200 GHz

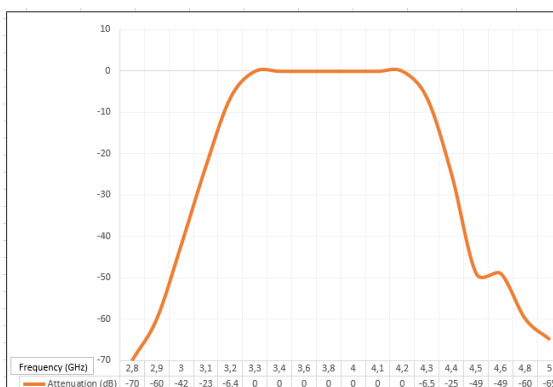

Filter characteristics for
model 5.15 E
3.400 - 4.200 GHz

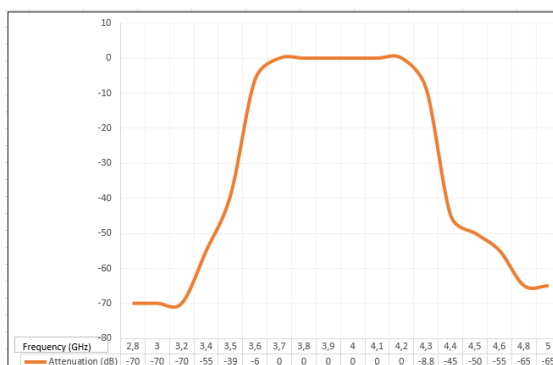

Filter characteristics for
model 5.15 B
3.700 - 4.200 GHz

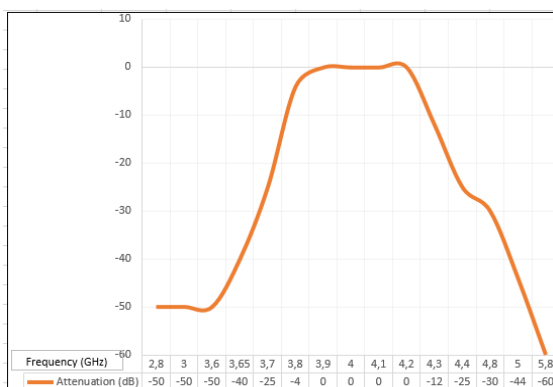

Filter characteristics for
model 5.30 C
3.800 - 4.200 GHz



Professional Satcom Frequency Converters & Components. All products are fully CE and RoHS compliant and every unit includes full documentation of performance tests and quality control. Please contact sales@smw.se to configure or customize the unit to your needs. Visit smw.se or scan QR code to see our full product range and request a quote.

